

Chillers and inverter Air/Water heat pumps with axial fans

Controller manual

Models

e-LITE



This manual has been created for informative purpose. The company declines any responsibility for the results of any projecting or any installation based on the explanations and/or on the technical specification provided in this manual. It is besides forbidden the reproduction under any form of the texts and of the figures contained in this manual. Data contained in this manual are not binding and may be changed by the manufacturer without notice. Manual in original language. Even partial reproduction PROHIBITED © Copyright - Advantix SpA

00	07-2023	M.S.	D.M.	First issue
Rev	Date	Author	Supervisor	Notes
Catalogo / Catalogue / Katalog / Catalogue MCO02530120000_00			Serie / Series / Serie / Serie / Série e-LITE CHRONOTHERMOSTAT	
<p>The electrical and electronic products and any waste should not be disposed of with normal household waste, but disposed of according to WEEE law in accordance with the directives 2012/19/EU and 2003/108/EC as amended, inquiring thereof at the place of residence or with the retailer in the case where the product is replaced with a similar one.</p>				

Contents

1. GENERAL INFORMATION	4
1.1 TECHNICAL DATA	4
2. EXPLOITATION CONDITIONS.....	4
3. CLEANING AND MAINTENANCE PROCEDURES.....	4
4. INSTALLATION	4
5. WIRING.....	6
7. DISPLAY ICONS.....	7
8. HEAT PUMP SCREEN.....	8
9. DHW SCREEN	11
10. THERMOSTAT SCREEN.....	13
10.1 THERMOSTAT SETPOINT SETTINGS.....	13
10.2 THERMOSTAT WORK MODE SETTINGS.....	14
11. MAIN MENU	15
11.1 DIAGNOSTIC INFO	15
11.2 ALARM LIST	15
11.3 ALARM HISTORY	15
11.4 UNIT SERIAL NUMBER.....	15
11.5 GENERAL SETTINGS.....	15
11.6 SERVICE MENU	15
11.6.1 UNIT SETTINGS.....	15
11.6.2 UNIT FORCING.....	17
11.6.3 UNIT UPDATE.....	17

1. GENERAL INFORMATION

The e-LITE device is a Modbus remote control panel with colour LCD and capacitive touch screen.

This device can be used as a remote control panel for the machine. It is equipped with a local sensor for temperature detection. Remote control panel with the roles of:

- Reads heat pump informations
- Sets heat pump working modes and setpoints
- Access to all parameters configuration
- Weekly ambient chronothermostat
- Anti-legionella cycle
- Alarm log

NOTES:

It can be configured with only one machine, it is not possible to manage a network of units.

1.1 TECHNICAL DATA

Supply voltage	12Vdc ($\pm 10\%$)
Supply frequency	50/60 Hz
Power	1.8 VA
Insulation class	III
Protection rating	IP20
Operating ambient temperature	0°C / + 50°C
Operating humidity	5% ÷ 85%
Ambient temperature for storage	0°C ÷ 65°C
Ambient humidity for storage	5% ÷ 85%
Overall dimensions	144.4 x 97.5 x 21 mm
Display	Color, graphical 480x272 pix, with touch panel.
Transmission	RS485 (ModBus RTU protocol)
Standards	EN 60730-2-9, EN 60730-1
Software update	Only microSD HC card (max. 32GB, FAT32 files format)
Air temperature probe	Accuracy is $\pm 0,5^{\circ}\text{C}$; Range 5°C – 35°C
(1) Class of the device	4
(1) Control contribution	2%

(1) According to REG UE 2013-811.

Technical data of the 12Vdc power supply, included in the box:

Supply voltage	230Vac
Power	6 VA
Overall dimensions	20 x 51 x 43 mm

2. EXPLOITATION CONDITIONS

Do not expose the control panel to direct weather conditions (rain, sunlight) and vibrations higher than typical during wheeled transport. Do not use in conditions of condensation and protect from water.

3. CLEANING AND MAINTENANCE PROCEDURES

The outer surface and maintenance of the control panel screen.

- The device should be cleaned with a soft, dry cloth.
- It is not allowed to clean the device with a flammable agent or substance (i.e. benzene or any kind of solvents) or a wet cloth. Such treatment can lead to malfunction of the device.
- It is not allowed to scratch the screen with nails or other sharp objects. It can lead to scratches or damage of the device.
- It is not allowed to clean the device by spraying water on it. If the water gets inside of the device it can cause a fire or lead to electrocution or damage the device.

4. INSTALLATION

The control is intended to be installed on the wall or placing it on the flat surface, only in dry room. Panel cannot be used under water vapor condensation conditions and must be protected against water. Room thermostat must be installed on the height allowing its convenient use, typically 1.5 m over the floor.

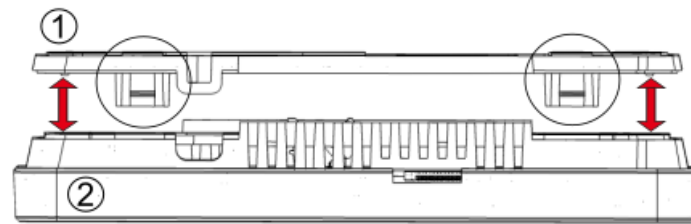

In order to reduce the interference of temperature measurement by the control panel, avoid sunny places with poor air circulation, close to the heating devices and places directly at doors and windows (typically at least 200 mm from the door edge).

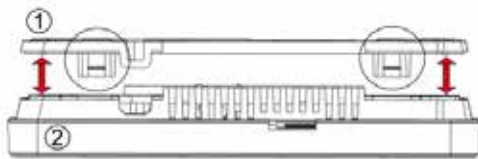

Control panel installation should be done according to the instructions below.

Disconnect the installation frame (1) from the back of room thermostat housing (2). The frame is attached to the panel housing with latches. Use a flat screwdriver to detach the frame.

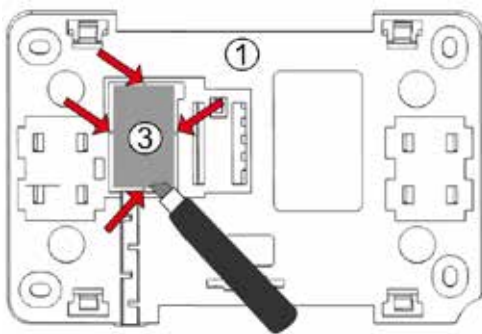

Using sharp tool cut out holes in four places of the cover (3) for the screw terminals.

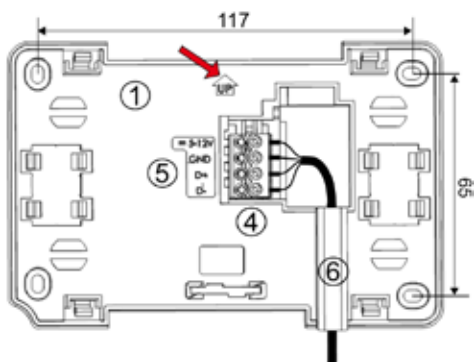

Connect the wires of a transmission cable, connecting control panel with the heat pump, to the screw terminal (4) as described on the plate (5). The cable connecting control panel with the heat pump can be recessed in the wall or can run over its surface – in such case the cable should be additionally placed in the cable channel (6) of the installation frame. The cable connecting panel with the heat pump cannot be conducted along with the cables of the building mains. The cable should not be routed near devices emitting strong electromagnetic field.

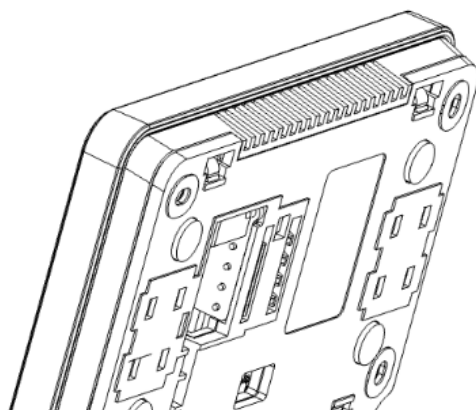

Drill holes in the wall and using screws (max. \varnothing 3 mm) fix the installation frame in the selected place on the wall, maintaining its proper position (UP). The spacing of holes can be determined by placing the frame on the wall. Next fix the panel to the installation frame using latches.

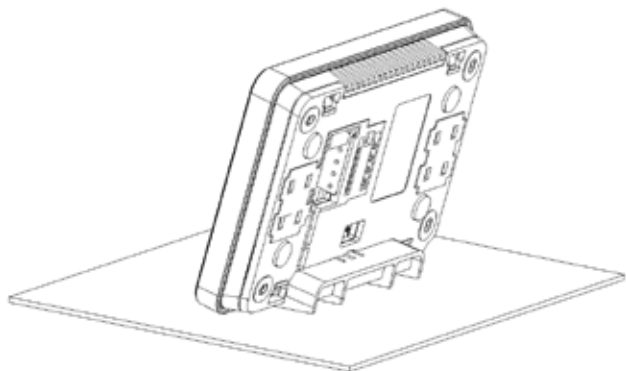

In order to place the control panel on a flat surface use a dedicated stand.

5. WIRING

You need two cables for the connection between the e-LITE remote control panel and the water chiller/heat pump unit:

- 5X1mm² twisted and shielded cable for Modbus communication D+/D-, PE, and 12Vdc power supply, which is included in the box.

NB: The shield of the cable must be connected to PE in both of its ends.

DESCRIPTION	e-LITE TERMINALS	CHILLER/HEAT PUMP TERMINALS (see documentation relating to the heat pump)	12 Vdc POWER SUPPLY	NOTES
POWER SUPPLY	VCC		SEC, red, +	
	GND		SEC, blk, -	
COMMUNICATION	D+	X-5.2 (i-32V5)		SHIELDED AND TWISTED CABLE
		XC-2.2 (i-32V5 Midi)		
		XR+ (i-HPV5)		
	D-	1A (i-290)		
		X-5.1 (i-32V5)		
		XC-2.1 (i-32V5 Midi)		
	XR- (i-HPV5)			
	1B (i-290)			
SHIELDING		PE clamp of the User terminal block		

6. SOFTWARE UPDATE



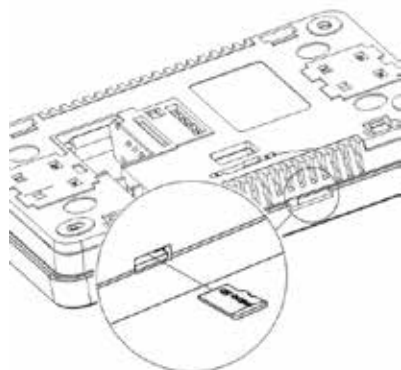











Software update is possible using only the microSD HC memory card (max. 32 GB, FAT32 files format) inserted into a slot in the control panel housing.

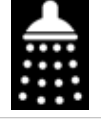



In order to replace the software, insert the memory card into the control panel slot - the software will be replaced automatically after inserting the card. The card should contain the new software in *.pfc format (the new software should be copied directly to the memory card, not to a subdirectory).

7. DISPLAY ICONS

The following is the list of main icons with relative meaning.

ICON	DESCRIPTION	NOTES
	Heat Pump screen	Opens the heat pump screen (startup screen).
	DHW screen	Opens the DHW screen.
	Thermostat screen	Opens the thermostat screen.
	Menu	Opens the menu screen.
	Cooling mode	Heat pump in Cooling mode.
	Heating mode	Heat pump in Heating mode.
	DHW mode	Heat pump in Domestic Hot Water mode.
	Comfort mode	Comfort set-point enabled.
	Economy mode	Economy set-point enabled.
	Compressor	White fixed symbol: compressor Off. White blinking symbol: compressor on call. Azure fixed symbol: compressor working.
	Circulator	White symbol: circulator Off. Azure symbol: circulator On.
	Alarm	List of active alarms.
	ON/OFF	Turns On or Off the Heat pump.
	Chrono scheduling	Turns On or Off the scheduling mode.
	Defrost	Blinking symbol if the defrost is in call. Fixed symbol if the defrost is in progress.

ICON	DESCRIPTION	NOTES
	Anti-freeze heater	The anti-freeze heater is working.
	Anti-legionella	Shown if the Heat pumps is doing the anti-legionella cycle. Fixed if the cycle is in progress. Blinking if the cycle is failed.



8. HEAT PUMP SCREEN

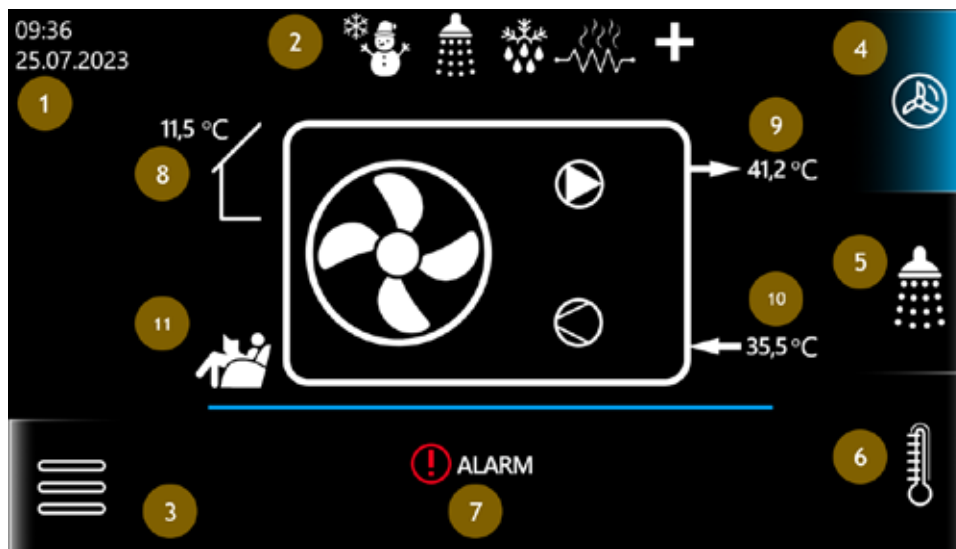





Heat pump settings main screen after the heat pump is turned on.



Number	Description
1	Time and date
2	Heat pump status bar (Work modes, defrost, anti-freeze heaters, anti-legionella) The message "NO COMMUNICATION" is shown, if there is no communication between heat pump main control board and e-LITE (in this case, check if the serial configuration is correct)
3	Main menu
4	Heat pump screen
5	DHW screen
6	Thermostat screen
7	Active alarms and active forcing
8	External temperature
9	Outlet water temperature
10	Inlet water temperature
11	Current heat-pump status

The possible status of the hat-pump are the following:

ICON	DESCRIPTION
	Manual comfort set-point enabled.
	Manual economy set-point enabled.

ICON	DESCRIPTION
	Manual heat pump in Stand-by mode.
	Cronothermostat enabled, with active comfort set-point.
	Cronothermostat enabled, with active economy set-point.
	Cronothermostat enabled, with active stand-by mode.
	Comfort set-point enabled, from digital input forcing (see heat-pump MCO, "second set-point from digital input").
	Economy set-point enabled, from digital input forcing (see heat-pump MCO, "second set-point from digital input").

Pressing the  symbol, the heat pumps work modes are displayed:

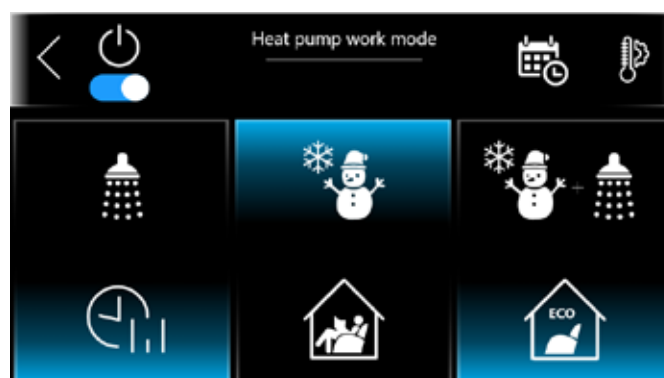

Tapping  symbol, the setpoint settings are displayed:

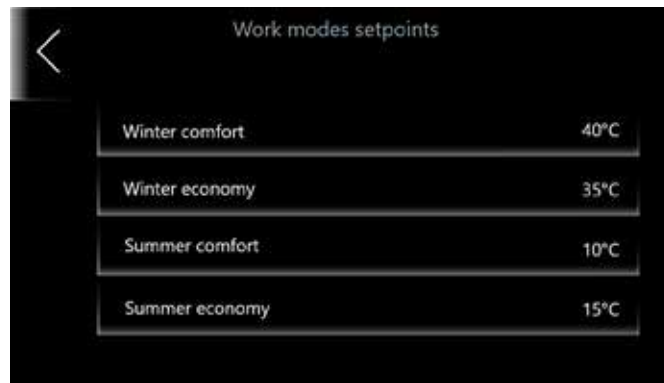

Tapping  symbol, the season and scheduling menu are displayed:

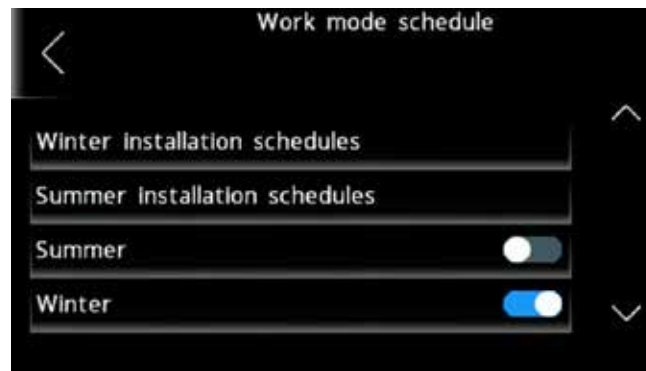



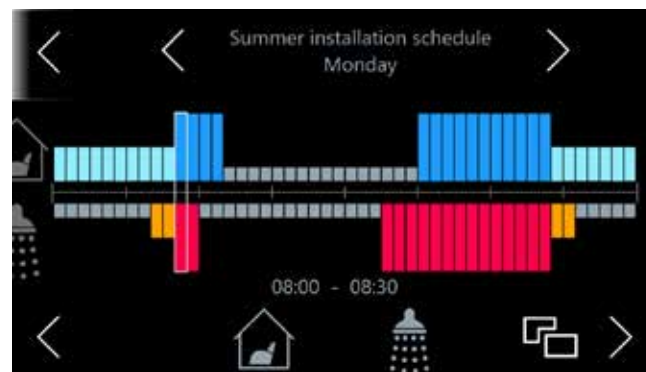





By tapping on the season switches, the selected season is activated for the heatpump and the thermostat function. Pressing Winter or Summer installation schedules, the scheduling screen is showed:



The strip represents the day, that is divided in 48 parts. Each part is 30 minutes. It is possible to change the day, with the > and < arrows. The upper part represents the plant water outlet enabling, the lower part represents the Domestic Hot Water enabling. The azure, lower strips represents cooling mode, Eco setpoint. The blue, higher strips represents cooling mode, comfort setpoint. The orange, lower strips represents heating mode, Eco setpoint. The red, higher strips represents heating mode, comfort setpoint. The gray strips represents disables mode.

The "copy symbol" , allows to select the days of the week, where we want to have the same program of the showed day. It's possible to scroll in left and right position, modifying every single area, by enabling the next symbols (by pressing the respective symbols):

ICON	DESCRIPTION
	Heat pump (water outlet configuration) OFF. By scrolling, the heat-pump plant water outlet configuration is disabled.
	Heat pump (water outlet configuration). By scrolling, the heat-pump plant water outlet configuration, in cooling mode with comfort set-point is enabled.

ICON	DESCRIPTION
	Heat pump (water outlet configuration). By scrolling, the heat-pump plant water outlet configuration, in cooling mode with economy set-point is enabled.
	Heat pump (water outlet configuration). By scrolling, the heat-pump plant water outlet configuration, in heating mode with comfort set-point is enabled.
	Heat pump (water outlet configuration). By scrolling, the heat-pump plant water outlet configuration, in heating mode with economy set-point is enabled.
	Heat pump DHW OFF. By scrolling, the heat-pump DHW configuration is disabled
	Heat pump DHW COMFORT. By scrolling, the heat-pump DHW configuration with comfort set-point is enabled.
	Heat pump DHW ECO. By scrolling, the heat-pump DHW configuration with economy set-point is enabled.

9. DHW SCREEN



In the center of the screen the temperature measured by the DHW probe is showed. On the right, below, the set-point temperature is showed.

By tapping on this screen, the DHW set-point edit screen is showed.

NOTE:

When the DHW is disabled, the next message is showed: "Domestic Hot Water support turned OFF. Press here to go to settings.".

By tapping, the next screen will be displayed:

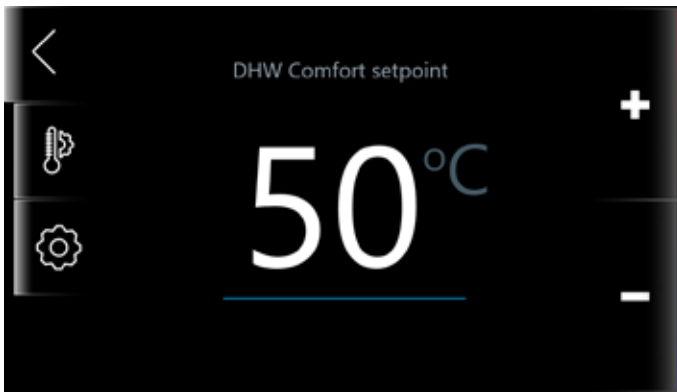

By pressing the gear symbol, it is possible to set the anti-legionella scheduling:

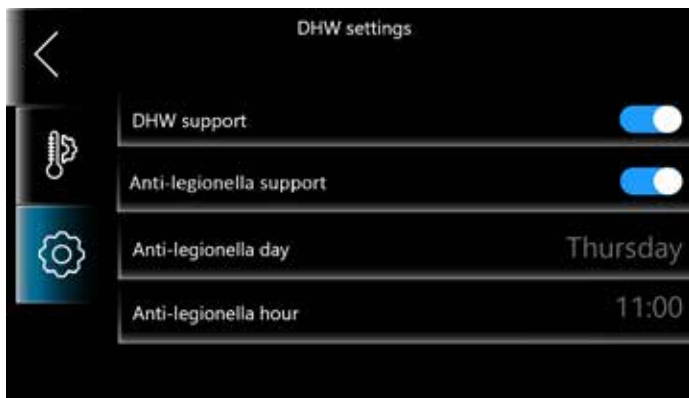

The DHW support switch, enables/disables the DHW function. The time in which the request for the anti-legionella cycle is sent is one hour. During this period, the DHW temperature must be higher than $r27$ [°C] (DHW setpoint during anti-legionella cycle), for $r26$ [minutes] (anti-legionella cycle duration).

The positive or negative results of the anti-legionella cycle, are stored in the Alarm History menu.

NOTE:
See the heat pump MCO, to configure and enable all the resources requested by DHW.

NOTE 2:
For the anti-legionella support, DHW support and all the requested resource must be enabled. See the heat pump MCO, to configure and enable all the resources requested by anti-legionella.

10. THERMOSTAT SCREEN



Thermostat function, uses the e-LITE internal probe, to measure the room temperature. By activating this function, the internal probe will be used to switch on or off the heat pump.

The thermostat call will be sent to the heat pump if:

- The unit is in cooling or heating
- The internal probe temperature hasn't reach the setpoint yet

For details of the behaviour of the machine in absence of the room call, refer to the machine specifications.

NOTE:
See the heat pump MCO, in order to set the types of regulation when the ambient probe is satisfied.
In the center of the screen the temperature measured by the internal probe is showed. On the right, below, the actual set-point temperature is showed.

10.1 THERMOSTAT SETPOINT SETTINGS

By tapping on the measured temperature, the thermostat set-point edit screen is showed:







By tapping on the gear symbol, the Thermostat settings are showed:

Function	Description	Range
Winter comfort preset	Comfort setpoint temperature for Winter mode.	Depending on heat pump parameters (see heat pump MCO)
Winter economy preset	Economy setpoint temperature for Winter mode.	
Summer comfort preset	Comfort setpoint temperature for Summer mode.	
Summer economy preset	Economy setpoint temperature for Summer mode.	
Thermostat hysteresis	After the air setpoint is reached, the thermostat call will be sent to the heat pump again, when the air temperature will: in heating mode: decrease lower than "air setpoint - Thermostat hysteresys" in cooling mode: encrease higher than "air setpoint + Thermostat hysteresys"	0°C - 5°C
Panel temperature correction	Correction from the temperature readed by the room probe	-5°C / +5°C

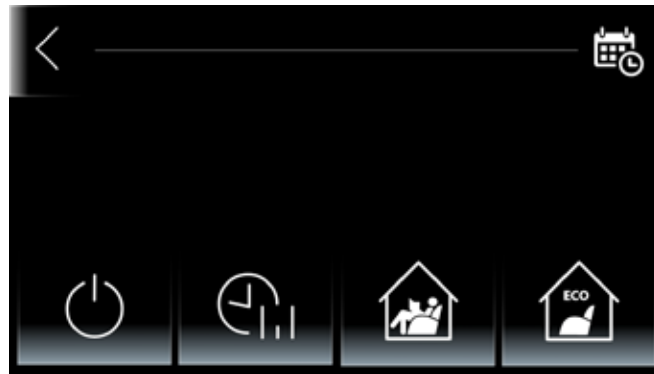
10.2 THERMOSTAT WORK MODE SETTINGS

On the main thermostat screen, tapping the status symbol below on the left, the thermostat work mode settings are shown:





ICON	DESCRIPTION	NOTES
	ON/OFF	Turns On or Off the Thermostat function
	Chrono scheduling	Turns On or Off the Thermostat scheduling mode
	Comfort mode	<ul style="list-style-type: none"> Switch to the comfort thermostat set-point in manual mode Showed if the crono schedule is active and in comfort mode
	Economy mode	<ul style="list-style-type: none"> Switch to the economy thermostat set-point in manual mode Showed if the crono schedule is active and in economy mode

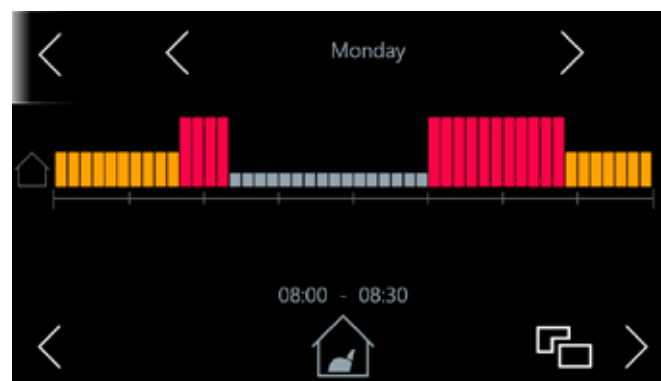



By pressing  symbol, the season and scheduling menu are displayed:



The strip represents the day, that is divided in 48 parts. Each part is 30 minutes. It is possible to change the day, with the > and < arrows.
 The azure, lower strips represents cooling mode, Eco setpoint.
 The blue, higher strips represents cooling mode, comfort setpoint.
 The orange, lower strips represents heating mode, Eco setpoint.
 The red, higher strips represents heating mode, comfort setpoint.
 The gray strips represents disables mode.

The "copy symbol" , allows to select the days of the week, where we want to have the same program of the showed day. It's possible to scroll in left and right position, modifying every single area, by enabling the next symbols:

ICON	DESCRIPTION
	Room temperature OFF By scrolling, the room temperature thermostat function, is disabled.

ICON	DESCRIPTION
	<p>Room temperature with comfort setpoint, in cooling mode. By scrolling, the room temperature with comfort set-point, in cooling mode is enabled.</p>
	<p>Room temperature with economy setpoint, in cooling mode. By scrolling, the room temperature with economy set-point, in cooling mode is enabled.</p>
	<p>Room temperature with comfort setpoint, in heating mode. By scrolling, the room temperature with comfort set-point, in heating mode is enabled.</p>
	<p>Room temperature with economy setpoint, in heating mode. By scrolling, the room temperature with economy set-point, in heating mode is enabled.</p>

11. MAIN MENU

From the home screen, by clicking in the menu symbol (below on left), the main menu is shown:

11.1 DIAGNOSTIC INFO

In this area, input and output values and work counters of the heat pump are shown.

NOTE:

Here you can also find Firmware version of the main control board and of the e-LITE.

11.2 ALARM LIST

Active alarm list. For detailed heat pump alarms, see the heat pump MCO.

Tapping the reset symbol , all the alarms that are no more active, will be reset.

11.3 ALARM HISTORY

Alarm historical, with date and hour of alarm start, and alarm stop.
In this list, the results of the anti-legionella cycle are saved.

11.4 UNIT SERIAL NUMBER

Heat pump serial number.

11.5 GENERAL SETTINGS

- Time and date
- Language
- Day brightness: percentage of display brightness, during the e-LITE use
- Night brightness: percentage of display brightness, in stand-by mode
- Touch sound: enables or disables the tapping sound

11.6 SERVICE MENU

This menu allows to access to the heat pump configurations and functions.
Password request is displayed (heat pump passwords).
User password: 0000.
Based on the level, different menus are shown.

11.6.1 UNIT SETTINGS

The visualized parameters, depends on the setted password, as described in the heat pump MCO (Par chapter).

11.6.2 UNIT FORCING



Note that the menu is password-protected.

- Reset alarm history in panel: resets e-LITE alarm history
- Reset alarm history: resets heat pump alarm history (stored on main control board)
- Reboot control board: reboots the heat pump main control board (enabled only when compressor is in stand-by)
- Defrost: forces a manual defrost (see conditions to enable defrost, in heat pump MCO)
- Plant deareation: activation of the circulator to force a plant deareation. Tapping on it, the function will be activated. With the active function, a tap on the name of the forcing, will disable it. Note that the command is only accepted by the heat pump if its status is OFF. The heat pump stops this forcing if the function mode change from OFF to a different mode, even if the entire forcing time has not yet elapsed.
- Pump forcing: This function is used to manually activate the system pump for recirculation with the pump at 100% for 1 hour. Tapping on it, the function will be activated. With the active function, a tap on the name of the forcing, will disable it. Note that the command is only accepted by the heat pump if its status is OFF. The heat pump stops this forcing if the function mode change from OFF to a different mode, even if the entire forcing time has not yet elapsed.
- Solar pump forcing: This function is used to manually activate the solar pump. Tapping on it, the function will be activated. With the active function, a tap on the name of the forcing, will disable it. Note that the command is only accepted by the heat pump if its status is OFF. The heat pump stops this forcing if the function mode change from OFF to a different mode, even if the entire forcing time has not yet elapsed.

NOTE:

When a forcing is activated, the main screen will be displayed.

11.6.3 UNIT UPDATE



Note that the menu is password-protected.

- FW UPDATE: update the main control board firmware
- PAR UPDATE: update the main control board parameters
- PAR EXPORT: export the main control board parameters and alarm historical.
- PROGRESS: progression status.

